

Impact Factor:

ISRA (India) = 4.971
ISI (Dubai, UAE) = 0.829
GIF (Australia) = 0.564
JIF = 1.500

SIS (USA) = 0.912
ПИИИ (Russia) = 0.126
ESJI (KZ) = 8.997
SJIF (Morocco) = 5.667

ICV (Poland) = 6.630
PIF (India) = 1.940
IBI (India) = 4.260
OAJI (USA) = 0.350

SOI: [1.1/TAS](https://doi.org/10.15863/TAS) DOI: [10.15863/TAS](https://doi.org/10.15863/TAS)

International Scientific Journal Theoretical & Applied Science

p-ISSN: 2308-4944 (print) e-ISSN: 2409-0085 (online)

Year: 2020 Issue: 06 Volume: 86

Published: 30.06.2020 <http://T-Science.org>

QR – Issue



QR – Article



Nodir Djakhongirovich Turakhodjaev
Tashkent State Technical University
t.s.d.professor

Nosir Muysinalievich Saidmakhamadov
Tashkent State Technical University
PhD doctorate

Ruslan Samadovich Zokirov
Tashkent State Technical University
PhD doctorate

Furkat Umarbekovich Odilov
Tashkent State Technical University
PhD doctorate

Kamola Utkurovna Tashkhodjaeva
Tashkent State Technical University
PhD doctorate

ANALYSIS OF DEFECTS IN WHITE CAST IRON

Abstract: This article analyzes the defects that occur in castings and discusses the factors that are the main causes of defects. It mainly analyzes three defects in the casting and considers the factors that cause defects in the alloy. It is also aimed at obtaining high-quality castings, depending on the composition of the alloy and the conditions of casting of liquid metal.

Key words: metallurgy, manganese, molybdenum, casting, alloy, defect, shrinkage, pipe, cavity, porosity, aluminium, copper, iron, lead, nickel, tin, zinc.

Language: English

Citation: Turakhodjaev, N. D., Saidmakhamadov, N. M., Zokirov, R. S., Odilov, F. U., & Tashkhodjaeva, K. U. (2020). Analysis of defects in white cast iron. *ISJ Theoretical & Applied Science*, 06 (86), 675-682.

Soi: <http://s-o-i.org/1.1/TAS-06-86-125> **Doi:**  <https://dx.doi.org/10.15863/TAS.2020.06.86.125>

Scopus ASCC: 2200.

Introduction

Foundries have defects in the castings, which, as a result, impair the processing of parts. Now metallurgy company conditions castings, like all metallurgical products, contain voids, inclusions and other imperfections which contribute to a normal quality variation. Such imperfections begin to be regarded as true defects or flaws only when the satisfactory function or appearance of the product is in question: consideration must then be given to the possibility of salvage or, in more serious cases, to rejection and replacement. This type of decision is dependent not only upon the defect itself but upon its

significance in relation to the service function of the casting and, in turn, to the quality and inspection standards being applied. The question of acceptance standards and the methods used for the detection of defects will be further reviewed of metallurgy company; the present metallurgy will be devoted to the causes and prevention of defects, to their significance, and finally to an appraisal of the techniques of rectification.

The general origins of defects lie in three sectors:

1. Shrinkage defects,
2. Contraction defects
3. Hot and cold cracks

Impact Factor:

ISRA (India) = 4.971
ISI (Dubai, UAE) = 0.829
GIF (Australia) = 0.564
JIF = 1.500

SIS (USA) = 0.912
ПИИИ (Russia) = 0.126
ESJI (KZ) = 8.997
SJIF (Morocco) = 5.667

ICV (Poland) = 6.630
PIF (India) = 1.940
IBI (India) = 4.260
OAJI (USA) = 0.350

Shrinkage defects

Shrinkage defects arise from failure to compensate for liquid and solidification contraction, so their occurrence is usually a symptom of inadequate gating and risering technique. The actual

form of defect depends upon design factors, cooling conditions and the mechanism of freezing of the alloy. Various types of internal cavity or surface depression are encountered [1,2]:

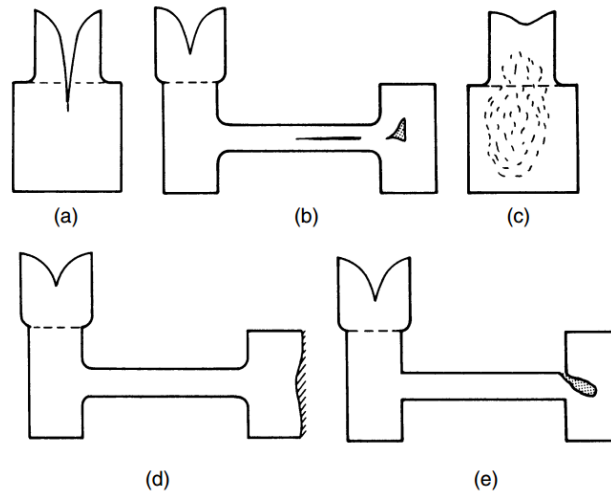

Figure 1. Forms of shrinkage defect. (a) Primary pipe, (b) secondary cavities, (c) discrete porosity, (d) sink, (e) puncture



Figure 2. Centre line shrinkage in plate section

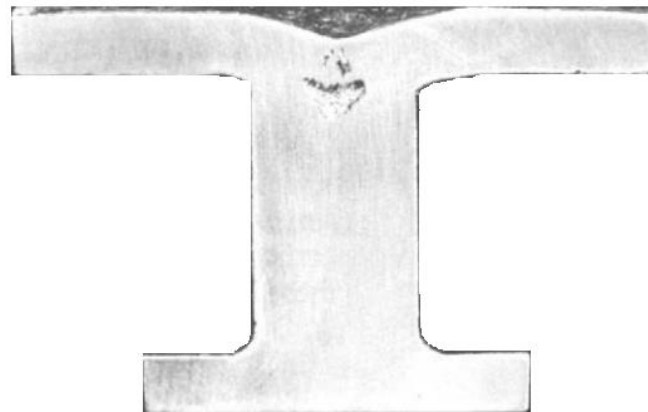

Figure 3. Sectioned casting exhibiting internal shrinkage cavity and sink

Major shrinkage cavities

Sharply defined cavities occur primarily in those alloys which solidify by skin formation and result either from premature exhaustion of the supply of feed metal or from failure to maintain directional solidification throughout freezing. The most conspicuous example is the primary shrinkage cavity or pipe resulting from an inadequate feeder head: due to lack of feed metal the final pipe extends into the casting, becoming visible on head removal (Figure 1 a).

Sporadic occurrence in a casting with a well established method must be attributed to some change in practice, for example omission of a feeding compound or cessation of pouring before the head was completely filled; drastic changes in pouring speed or casting temperature are other possible causes. Since the defect is localized rectification by welding is sometimes feasible.

Unlike primary shrinkage, secondary shrinkage is wholly internal and occurs in positions remote from the feeder head. Depending on the severity of the

Impact Factor:

ISRA (India)	= 4.971	SIS (USA)	= 0.912	ICV (Poland)	= 6.630
ISI (Dubai, UAE)	= 0.829	ПИИИ (Russia)	= 0.126	PIF (India)	= 1.940
GIF (Australia)	= 0.564	ESJI (KZ)	= 8.997	IBI (India)	= 4.260
JIF	= 1.500	SJIF (Morocco)	= 5.667	OAJI (USA)	= 0.350

conditions, the defect may be a massive cavity or a filamentary network. Typical sites include the central zones of extended parallel walled sections and local section increases where no provision has been made either for direct feed or selective chilling (Figure 1 b). Although this form of cavity is inaccessible for repair, its location near to the neutral axis of stress diminishes its influence on the strength of the casting. Typical examples of internal shrinkage cavities are seen in Figures 2 and 3.

Contraction defects

The cooling of cast metal from the solidus to room temperature is accompanied by considerable further contraction. The magnitude of this contraction is indicated in Table 1 where the coefficients of thermal expansion of a number of metals provide the basis for a rough estimate of the total linear contraction in the solid state.

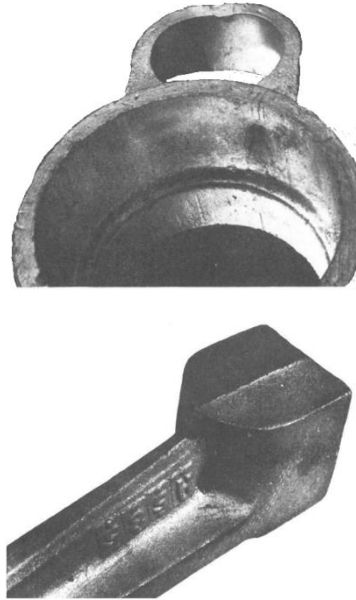

Figure 4. Two examples of shrinkage puncture or 'draw'

Unlike the liquid and solidification shrinkages, which can be compensated by an influx of liquid, solid contraction affects all linear dimensions of the casting,

hence the need for standard pattern allowances in accordance with the expected contraction behavior of the alloy.

Table 1. Solid contraction of some metals

Metal	Coefficient of linear* expansion deg C ⁻¹ x 10 ⁶	Melting point °C	Approximate total linear contraction to 20 ⁰ C %
Aluminium	29,2	660	1,9
Copper	20,6	1083	2,2
Iron	17,3	1536	2,6
Lead	31,6	327	1,0
Magnesium	31,4	649	2,0
Nickel	18,4	1453	2,6
Tin	24,4	232	0,5
Zinc	35,9	420	1,4

*Mean value for range 20°C–T_M, estimated by extrapolation from data in Reference.

No allowance is made for phase changes in the solid state.

Dimensional change due to solid contraction would be expected to begin as soon as a coherent solid mass is formed, whether a surface layer or a more extensive network of crystals. Under practical conditions, however, castings never contract completely freely and the metal must develop

sufficient cohesive strength to overcome significant resistance. Hindrance to contraction may be offered by the mould, by hydrostatic pressure of residual liquid and by other parts of the casting itself due to differential cooling. Stresses can thus arise either from external restraint or from thermal conditions alone. (Figure 5.)

Impact Factor:

ISRA (India) = 4.971
ISI (Dubai, UAE) = 0.829
GIF (Australia) = 0.564
JIF = 1.500

SIS (USA) = 0.912
ПИИИ (Russia) = 0.126
ESJI (KZ) = 8.997
SJIF (Morocco) = 5.667

ICV (Poland) = 6.630
PIF (India) = 1.940
IBI (India) = 4.260
OAJI (USA) = 0.350

The effect on the casting depends upon the severity of restraint relative to the mechanical properties of the cast metal at successive stages during cooling. If the restraint is readily overcome, the casting will contract in a predictable manner and no

defect will occur. More rigid hindrance produces tensile strain and a defect may ensue. The form of the defect will depend upon the mechanical properties at the point in the cooling sequence when the restraint becomes critical [3,4].

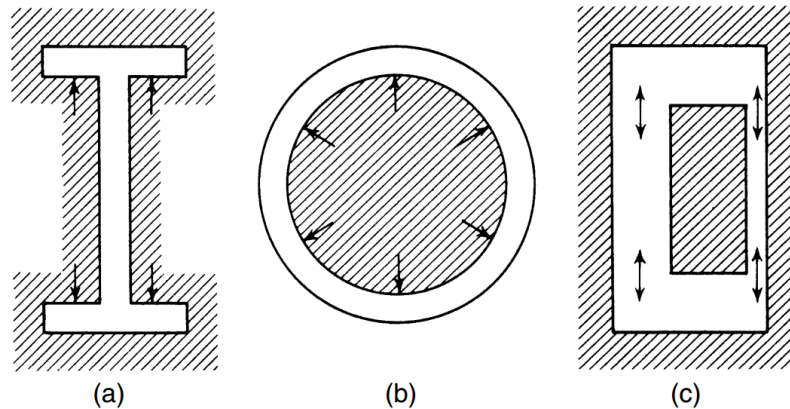

Figure 5. Typical design features giving rise to contraction stresses.
(a) Mould restraint, (b) core restraint, (c) differential contraction of casting members

During the cooling of a casting from the molten state down to shop temperature the mechanical properties can be related to four stages of behavior:

1. That period of solidification during which there is no long range cohesion and when sufficient liquid is present for mass and interdendritic feeding to compensate for contraction. This may be termed the liquid–solid stage and the metal has negligible strength but infinite ductility.

2. The stage when solidification is well advanced but when small amounts of residual liquid delay the development of full cohesion. Contraction behavior is essentially that of a solid but the metal is weak and ductility almost though not entirely absent. This may be termed the solid–liquid or coherent brittle stage.

3. The high temperature solid region in which the metal has developed limited strength and a capacity for plastic deformation without strain hardening.

4. The lower temperature solid region associated with relatively high strength and elastic behavior.

If the resistance to contraction becomes critical at the highest temperatures, when the alloy is in a relatively brittle condition due to liquid films, hot tearing occurs. If the casting survives this vulnerable stage, the development of contraction hindrance at lower temperatures may cause plastic deformation, residual elastic stress or low temperature cracking,

depending upon the severity and timing of the restraint. This is governed by the rate of contraction and by the mechanical properties of both metal and mould.

Strengths of moulding materials, although low when compared with those of metals at normal temperatures, are comparable to those in the solidus region. As the temperature falls this source of hindrance becomes less significant relative to the growing strength of the metal and the main resistance occurs within the framework of the casting itself. Differences in cooling and contraction rates between separate parts of the casting may arise from section thickness variations, from initial temperature gradients produced by the gating technique, or from the cooling environment. The cooling situation may, for example, be such that heat loss from certain sections is accelerated by partial exposure or by draughts, whilst that of other sections is retarded by sand insulation or radiation shielding.

The development of stresses through differential cooling was the subject of several notable studies. The basic mechanism is best explained with reference to a simple stress grid casting of the type illustrated in Figure 6 a, in which the thin members A tend to cool more rapidly than the thick members B.

Impact Factor:

ISRA (India)	= 4.971	SIS (USA)	= 0.912	ICV (Poland)	= 6.630
ISI (Dubai, UAE)	= 0.829	ПИИИ (Russia)	= 0.126	PIF (India)	= 1.940
GIF (Australia)	= 0.564	ESJI (KZ)	= 8.997	IBI (India)	= 4.260
JIF	= 1.500	SJIF (Morocco)	= 5.667	OAJI (USA)	= 0.350

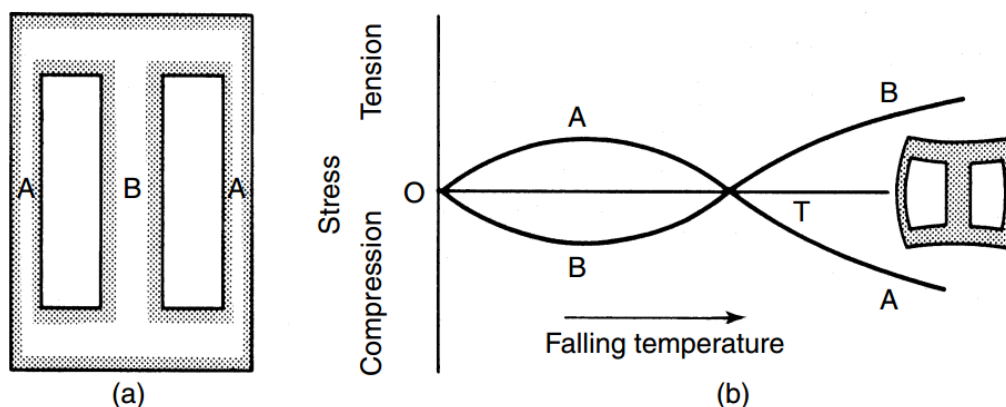

Figure 6. Development of stresses through differential contraction.
(a) Stress grid casting (b) schematic plot of stresses in thick and thin members, illustrating change in sign during cooling

Initially the thinner and more rapidly cooled sections pass through the brittle temperature range, during which stage hot tearing may occur due to mould restraint. As the whole casting cools into the plastic region, high stresses are not generated since differential contraction is readily accommodated by plastic strain. On further cooling, however, the thinner members acquire elastic behavior and their further contraction places the more slowly cooled and still plastic regions B under compression, producing permanent deformation. As these compressed regions themselves become elastic and complete their cooling, they encounter restraint from the now cold thinner sections and residual elastic stresses are produced in the system. The more rapidly cooled sections A carry a residual compressive stress whilst the last sections to cool B are now in tension. In general, therefore, light sections and the surface zones of castings tend to be left under compressive stress and heavy sections and interior zones in tension.

This development of the stress pattern is schematically illustrated in Figure 6 b. The initial phase of the diagram represents the period during which any failure will occur in the thin members at a hot spot or stress concentration. To the right of the point of inversion the risk changes to one of residual stress or of cold cracking in the regions now under tension. In alloys which undergo transformations on cooling, the stress pattern may be modified by accompanying temperature and volume changes [5].

Hot and cold cracks

The formation of hot and cold cracks in castings from white cast iron is associated with low thermal

conductivity and ductility, as well as a large linear shrinkage of these alloys. These properties in difference-walled castings lead to a significant temperature difference and, when shrinkage is difficult, cause the formation of hot cracks.

The tendency to form hot cracks was determined by the technological sample – ring with the boss. The inner surface of the ring (with a diameter of 160 mm, a thickness of 4 mm, a height of 30 mm, and a flat boss 20 mm thick and 40 mm long) was formed by dry sand-clay cores, the compliance of which depended on the composition of the core mixture. The compliance of the rods was changed due to different clay contents (from 7 to 20%). 4% sawdust was added to the most malleable mixture. The index of resistance to hot cracks was determined by the appearance of cracks in the boss. The results of the study are given in table. 2, show that white pearlite cast iron is most prone to the formation of hot cracks - technological samples from this alloy had cracks for all compositions of the rod mixtures, including the most malleable, containing 4% sawdust. Cast iron has almost the same low resistance to hot cracks - samples from this alloy had cracks for all rod compositions, with the exception of the most malleable composition with 4% sawdust – point 1. The lowest tendency to form hot cracks was shown by cast iron with a high chromium content - ICh290X28N2, ICh210X30G3, 280X29NL, 300X32N2M2TL and Ch260X17N3G3 cast iron, possibly due to the fact that the compositions of these cast iron are closer to eutectic [6].

Impact Factor:

ISRA (India)	= 4.971	SIS (USA)	= 0.912	ICV (Poland)	= 6.630
ISI (Dubai, UAE)	= 0.829	ПИИИ (Russia)	= 0.126	PIF (India)	= 1.940
GIF (Australia)	= 0.564	ESJI (KZ)	= 8.997	IBI (India)	= 4.260
JIF	= 1.500	SJIF (Morocco)	= 5.667	OAJI (USA)	= 0.350

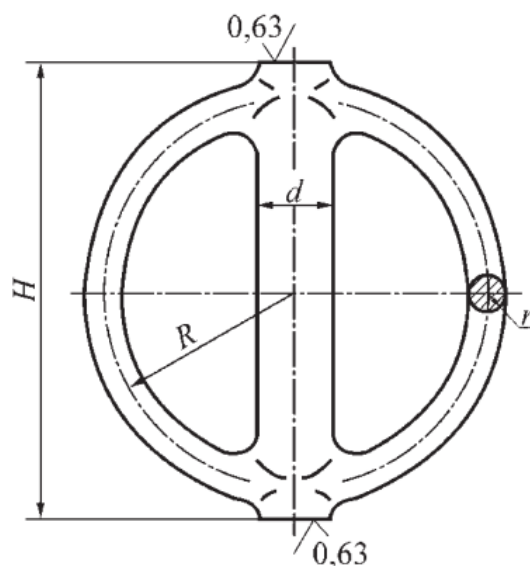

Figure 7. Sample lattice for determining residual stresses.

The Department of “Casting Technologies” recommends that casting at a temperature of not more than 1380° C be recommended to prevent the formation of hot cracks in castings from high-chromium cast irons.

The tendency to form cold cracks. The practice of foundries shows that white cast iron is prone to the formation of cold cracks. This phenomenon is associated with low thermal conductivity and ductility and a large modulus of elasticity of white cast irons. Thus, according to [7], for high-chromium cast iron, $\lambda = 1.7 \text{ W / (m}\cdot\text{K)}$, $E = 170 \text{ kN / mm}^2$, while for gray cast iron $\lambda = 50\div 73 \text{ W / (m}\cdot\text{K)}$ and $E = 84\div 140 \text{ kN / mm}^2$.

The tendency to the formation of cold cracks—one of the main characteristics that determine the manufacturability of white cast iron - was studied by the value of the residual stresses in a special sieve (Fig. 7), which admits significant bending deformations, which are very measurable [7].

To obtain a comparative assessment of the tendency to form cold cracks in a wet sandy-clay form, a pellet was molded (Fig. 7) with a central massive bridge. After knocking out and cleaning, the flat jumpers were ground and the length H of the jumpers was measured with an accuracy of 1 MKM. Then the central jumper was cut with an abrasive wheel 2 mm thick.

After that, H was again measured and the elastic residual deformation ΔH was determined to calculate the force P acting in the lattice until it was cut, and the stress in the ring and jumper.

To calculate the effort P used the formula:

$$P = 5,2 r^4 E \Delta H / R^3 \quad (1)$$

where: r is the radius of the cross section of the ring; E — modulus of elasticity, kN/mm^2 ; ΔH is the residual strain; R is the average radius of the lattice, mm.

The maximum tensile stresses in the ring were determined by the formula:

$$\sigma_{ocm} = 0,4 (RP / r^3)$$

The elastic modulus is adopted for cast iron 220 kN / mm^2 , for steel 210 kN/mm^2 .

The residual stresses in the shrink lattice depend on the content of carbon and chromium in the cast iron and, as a result, on the eutecticity of the cast iron (Fig. 8, Table 2).

The maximum residual stresses of 150–370 N/mm^2 are observed in pre-eutectic cast irons with 12% Cr. In cast irons with 30% Cr, residual stresses are much lower — 28–130 N / mm^2 .

According to the formula [8], the degree of eutecticity of cast irons was calculated

$$S_e = \frac{\% C}{4,3 - 0,3 (\% Si) + 0,03 (\% Mn) - 0,07 (\% Ni) - 0,05 (\% Cr)}$$

Impact Factor:

ISRA (India) = 4.971	SIS (USA) = 0.912	ICV (Poland) = 6.630
ISI (Dubai, UAE) = 0.829	ПИИИ (Russia) = 0.126	PIF (India) = 1.940
GIF (Australia) = 0.564	ESJI (KZ) = 8.997	IBI (India) = 4.260
JIF = 1.500	SJIF (Morocco) = 5.667	OAJI (USA) = 0.350

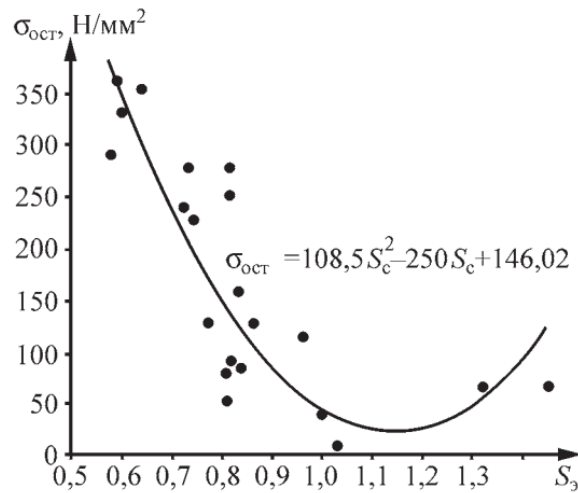

Fig. 8. The influence of the degree of eutecticity of white chromium cast irons on the level of residual stresses

Table 2. The value of residual stresses of various alloys [9]

Alloyed	$\Delta H, mm$	P, kilo	$\sigma_{OCT} H/mm^2$
Cast iron 30L	0,057	116,6	34
ICh220X12G3M	0,577	1292,8	367
	0,560	1311,0	360
ICh210X12G4	0,523	1224,4	336
	0,455	1065,2	292
ICh280X12G5	0,375	903,7	243
	0,440	1030,1	283
	0,405	864,8	254
	0,398	904,9	234
	0,440	939,6	276
ICh290X12G3M	0,235	615,3	161
	0,197	504,6	129
ICh290X28N2	0,125	270,0	79
	0,160	374,6	103
	0,044	98,6	28
	0,103	241,1	66
	0,103	241,1	66
ICh210X30G3	0,010	234,0	60
	0,085	199,0	55
	0,143	334,8	92
	0,130	327,1	85
	0,203	475,2	130
	0,170	457,4	114

Figure 8 shows that the level of residual stresses of chrome cast iron decreases with its composition approaching eutectic.

The article focuses on three defects in the casting because these defects have a significant effect on the

operating conditions of the castings. This means we can get quality castings by avoiding defects in the casting.

Impact Factor:	ISRA (India) = 4.971	SIS (USA) = 0.912	ICV (Poland) = 6.630
	ISI (Dubai, UAE) = 0.829	PIHII (Russia) = 0.126	PIF (India) = 1.940
	GIF (Australia) = 0.564	ESJI (KZ) = 8.997	IBI (India) = 4.260
	JIF = 1.500	SJIF (Morocco) = 5.667	OAJI (USA) = 0.350

References:

1. Beeley, P. (2001). *“Foundry Technology”*, Butter Worth Heinemann, 2nd ed.
2. Turakhodjaev, N., Tursunbayev, S., Tashbulatov, S., & Kuchkorova, M. (2020). “Analysis of technological solutions for reducing the copper concentration in slags from oxygen-flare smelting of copper sulfide concentrates” *Journal of Critical Reviews* 2020 year ISSN- 2394-5125 Volume 7, Issue 5, 2020, p.10. (Scopus indexed) <http://dx.doi.org/10.31838/icr.07.05.95>Tayvan Tashkent 2.
3. Tursunbaev, S.A. (2019). “An analysis of electrolytic in-process dressing (elid) grinding” *SCIREA Journal of Mechanical Engineering*. Mechanical October 6,2019 Volume 2, Issue 3, CHINA. <http://www.scirea.org/journal/>
4. Bekmirzaev, Sh., Saidmakhamadov, N., & Ubaydullaev, M. (2016). “Obtaining sand-clay casting”. *Theory and practice of modern. – Russia*, №4 (12), p.112.
5. Campbell, J. (2011). *Complete Casting Handbook first edition*.
6. Dovgalevskiy, Ya.M. (n.d.). *Cast iron with special properties*. Moscow: Metallurgizdat.
7. Samsanov, V.I. (n.d.). *Investigation of the conditions for the appearance of macroscopic residual stresses in molded products*. Abstract. dis. Cand. tech. sciences. Moscow.
8. Girshivich, N.G. (n.d.). *Crystallization and properties of cast iron in castings*. ML: Mechanical Engineering.
9. Sipin, I.I., Garber, M.E., & Mikhaylovskaya, S.S. (n.d.). *New abrasive-corrosion white cast iron*. Foundry. Number 9.
10. Farxodjonqizi, F.N., & Dilshodjonugli, N. S. (2020). Innovative processes and trends in the educational process in Uzbekistan. *ACADEMICIA: An International Multidisciplinary Research Journal*, T. 10, №. 4, pp.621-626.
11. Naymanbaev, R., Tokhirov, M., Sabirov, S.S., & Nurdinov, R.A. (2012). *On nature of anomalous photovoltaic effect in semiconductor films of telluride copper and indium*. Uzbekistan, pp. 311-315. Retrieved from <https://www.osti.gov/etdeweb/biblio/22249627/>